



OpeTrack Gantry



OWNER'S MANUAL

(To Be Retained by Owner After Installation by Authorized OpeMed Dealer)

Part No. 001077-EN, Rev. 000
15-m03-2017

IMPORTANT

Be sure to read this entire manual before using the OpeTrack Gantry (Gantry). The information in this manual is important for the safety of the person being transferred and the operator, and for the proper use and maintenance of the Gantry. Transfer always presents a potential risk and this manual provides important safety information that must be read and understood to help prevent injuries.

Unauthorized modifications to this Gantry may affect its safety. OpeMed (Europe) Ltd. will NOT be held responsible for any accidents, incidents or performance deficiencies that occur due to any unauthorized modification to this Gantry. To avoid potential injury due to the use of inadequate parts, always use only OpeMed replacement parts.

Regularly scheduled maintenance must be performed on your Gantry by an Authorized OpeMed Dealer to ensure safety and proper operation of the lift. Refer to the Maintenance section in this manual.

Legal Manufacturer:

Savaria Concord Lifts, Inc.
2 Walker Drive
Brampton, Ontario L6T 5E1
Canada

European Representative:



OpeMed (Europe) Ltd.
Clockhouse, Farnham,
Surrey, GU9 7UD, United Kingdom

Copyright © 2017
OpeMed (Europe) Ltd.
All rights reserved.

Printed in Canada and UK

STANDARD NOTATIONS

The following notations may be used throughout this manual to emphasize important safety information, mechanical concerns, and other important information. Please review and follow all of these messages.

 DANGER	Danger messages indicate an imminently hazardous situation, which, if not avoided, results in death or serious injury. All danger messages feature a standard ISO safety alert symbol followed by the signal word DANGER in capitalized black lettering on a red background.
 WARNING	Warning messages indicate a potentially hazardous situation, which, if not avoided, could result in death or serious injury. All warning messages feature a standard ISO safety alert symbol followed by the signal word WARNING in capitalized black lettering on a dark yellow background.
 CAUTION	Caution messages indicate a potentially hazardous situation, which, if not avoided, could result in minor injuries. All caution messages feature a standard ISO safety alert symbol followed by the signal word CAUTION in capitalized black lettering on a yellow background.
NOTE	Note messages provide information, such as reminders, general information about a previous statement, or additional guidelines that do not fit into the flow of the preceding text. All note messages include the signal word NOTE in capitalized white lettering on a blue background.

CONTENTS

1. OVERVIEW	5
Intended Use	5
Product Life	5
Using This Manual	5
2. SAFETY INSTRUCTIONS	6
To Ensure Safety	6
3. DESCRIPTION	7
Installation	7
Symbols	14
4. SPECIFICATIONS	16
Dimensions	17
6. MAINTENANCE	18
Operator Maintenance Schedule	18
Dealer Maintenance Schedule	19
Inspection and Cleaning	19

1. OVERVIEW

Intended Use

The OpeTrack Gantry is designed for use by caregivers and health care professionals to lift and transfer a person in a homecare, assisted-living or hospital environment. Transfer must be performed by a qualified operator as described in this manual. **Do NOT use the Gantry for any other purpose.**

Product Life

The Gantry is designed for a useful life of 10 years after which time it must be replaced. To ensure this life span, you must perform the preventive maintenance as specified in the Maintenance section in this manual.



OpeMed (Europe) Ltd. cannot ensure complete safety for a Gantry that has exceeded its useful life. Wear may cause failure or a part and lead to a patient fall.

Using This Manual

To ensure safe operation of the Gantry, read this entire manual carefully, especially the Safety Instructions, before installing, using or maintaining the Gantry. Failure to comply with all WARNINGS in this manual may result in injury. If there is anything you don't understand, contact your Authorized OpeMed Dealer for further details.

Keep this manual with the Gantry and ensure all operators are fully trained in the use of the lift with the Gantry as described in this manual.

2. SAFETY INSTRUCTIONS

Keep these *Safety Instructions* with the Gantry at all times. Read this entire manual

before installing, using or maintaining the Gantry.



Do NOT use the Gantry for any purpose other than to transfer a person. To ensure safety of the person being transferred and the operator, follow all Safety Instructions.

Do NOT push, bump or smash the rail or posts to avoid flipping the Gantry or damaging components. Any damage to the structure could result an injury or death.

To Ensure Safety

- The Gantry has a safe working load of 272 kg (600 lb), 200 kg (440 lb) or 130 kg (286 lb). Do NOT exceed this load. Refer to the span chart tag on the legs of the Gantry or to the Specifications section in this manual for the maximum load allowed.
- The FSS must be installed by an Authorized Savaria Dealer.
- Ensure the FSS is used only with a Savaria ceiling track and ceiling lift. If the track system or lift are not from OpeMed, ensure the tracks and lift are properly assessed by a competent authority for fit, function, and safety.
- The FSS must be installed by a trained and Authorized Savaria Dealer. We recommend to be 2 persons to avoid any injury.
- Check with a qualified health professional to ensure the person to be transferred has been deemed suitable for transfer.
- Take extra care with a person who is connected to electrodes, catheters or other medical devices to ensure safe transfer.
- Take care to avoid impact during transfer.
- Keep all components of the FSS clean and dry.
- Ensure all checks and actions are performed at the frequency indicated in the *Maintenance* section in this manual.
- Do NOT use as a swing seat.

3. DESCRIPTION

Installation

The Gantry kit includes the items shown below.

Figure 1



- 1 Install the posts in the bases (x2).

Figure 2

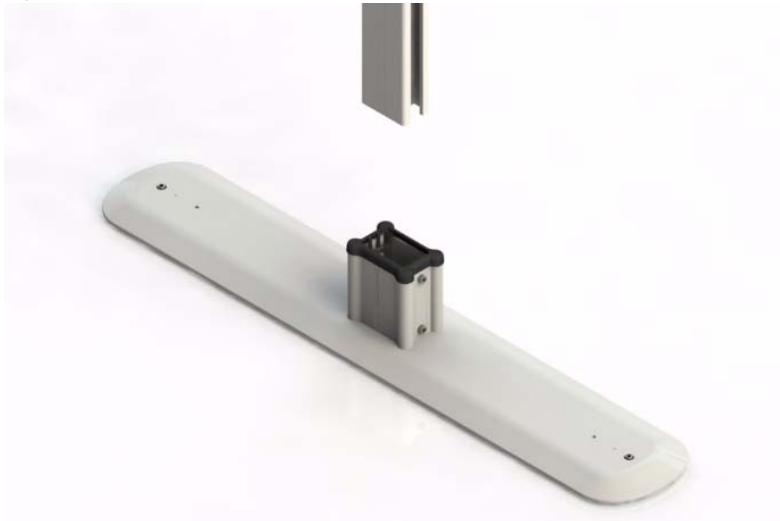

2 Tighten the screws (x8) to a torque of 20 N-m, +/-3 (15 lb-ft).

Figure 3

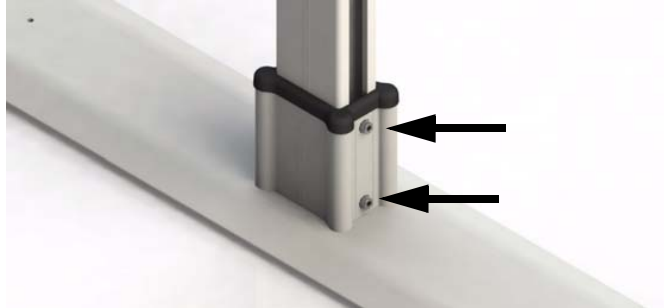

3 Install the upper rail attachment assembly (x2).

Figure 4



4 Tighten the screws (x8) to a torque of 20 N-m, +/-3 (15 lb-ft).

Figure 5

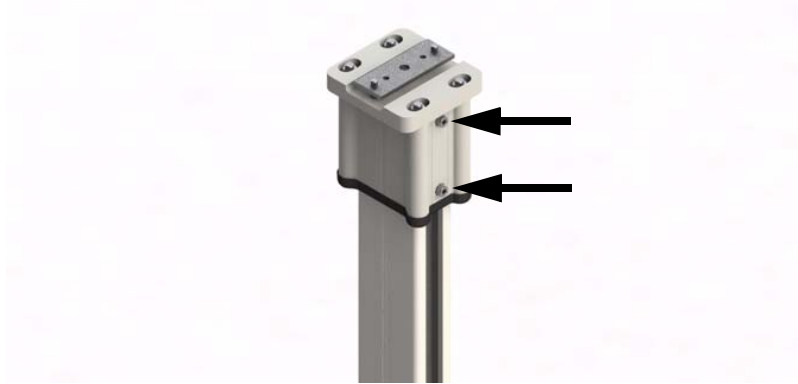

5 Insert the trolley (x1, ordered separately) and the end stoppers (x2).

Figure 6



- 6** Install the upper rail. Note that it must be installed flush with the outside of the post bracket.

Figure 7



- 7** Tighten the screws (x4) to a torque of 20 N-m, +/-3 (15 lb-ft).

Figure 8



8 Tighten the screws (x4) to a torque of 20 N-m, +/-3 (15 lb-ft).

Figure 9



9 Install the end caps (x2).

Figure 10



10 Install the PVC strips (x4).

Figure 11



11 Adjust for level. Ensure there are no gaps over 1/4" (6 mm) to prevent children from trapping their fingers.

Figure 12

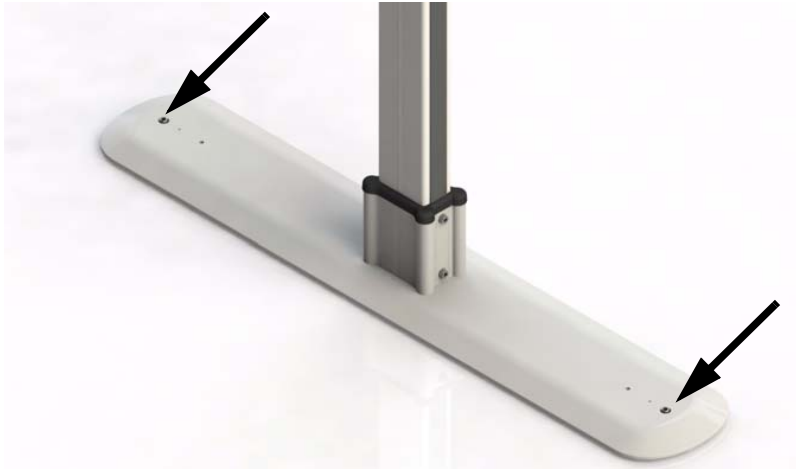





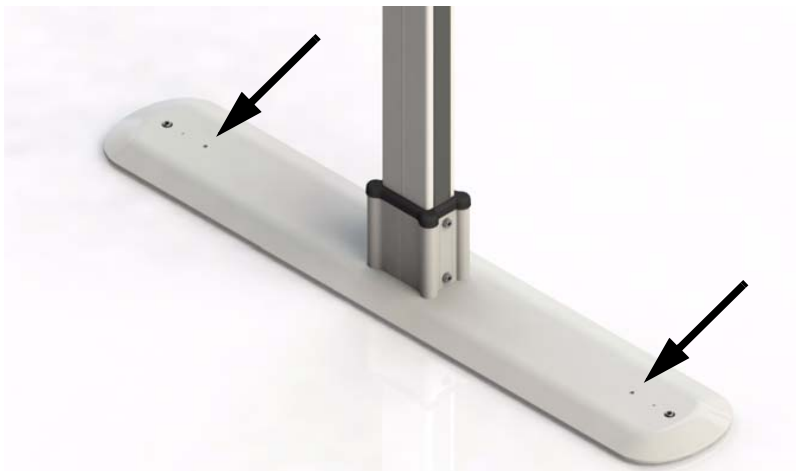



12 Optional - Use anchor bolts to attach the bases (x2) to the floor.



Figure 13



Symbols

The following chart illustrates the symbols used on the nameplate, the packaging and the lift.

Symbols on nameplate	
 YYYY-MM	Indicates the medical device manufacturer. This symbol is accompanied by the address of the manufacturer and the date of the manufacturer. YYYY: Represents the year MM: Represents the month
	Indicates the authorized representative in the European Community. This symbol is accompanied by the address of the authorized representative.
	Indicates the manufacturer's catalogue number
	Indicates the manufacturer's serial number
	Keep dry
	Indicates the product complies with the medical device directive 93/42/EEC
	Caution
MAX . LOAD :	Refers to the greatest permissible load that can be applied to the product
Symbols on box label	
	Indicates the temperature limits to which the medical device can be safely exposed

	Indicates the range of humidity to which the medical device can be safely exposed
	Indicates the range of atmospheric pressure to which the medical device can be safely exposed

4. SPECIFICATIONS

Product	
Product Weight	Base assembly: 32 kg (71 lb) Post: 7.2 kg each (16 lb each) Track: 3.14 kg/m (2.2 lb/ft)
Product Life	10 years
Safe Working Load (SWL)	130 kg (286 lb) or 200 kg (286 lb) depending on the span chart
Environmental Conditions	
Operating Temperature	5 °C to 40 °C (41 °F to 104 °F)
Operating Humidity	15 to 93%, non-condensing
Storage Temperature	-25 °C to 70 °C (-13 °F to 158 °F)
Storage Humidity	0 to 93%, non-condensing
Atmospheric Pressure	70 kPa to 106 kPa
Compliance	
ISO10535:2006,	
MDD 93/42 /EEC	

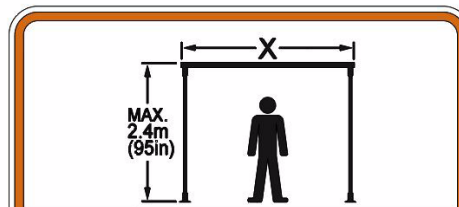

MAXIMUM SPAN (X)	
RAIL	
LOAD	
130kg (286lb)	3.0m (118in)
200kg (440lb)	2.5m (98in)

Dimensions

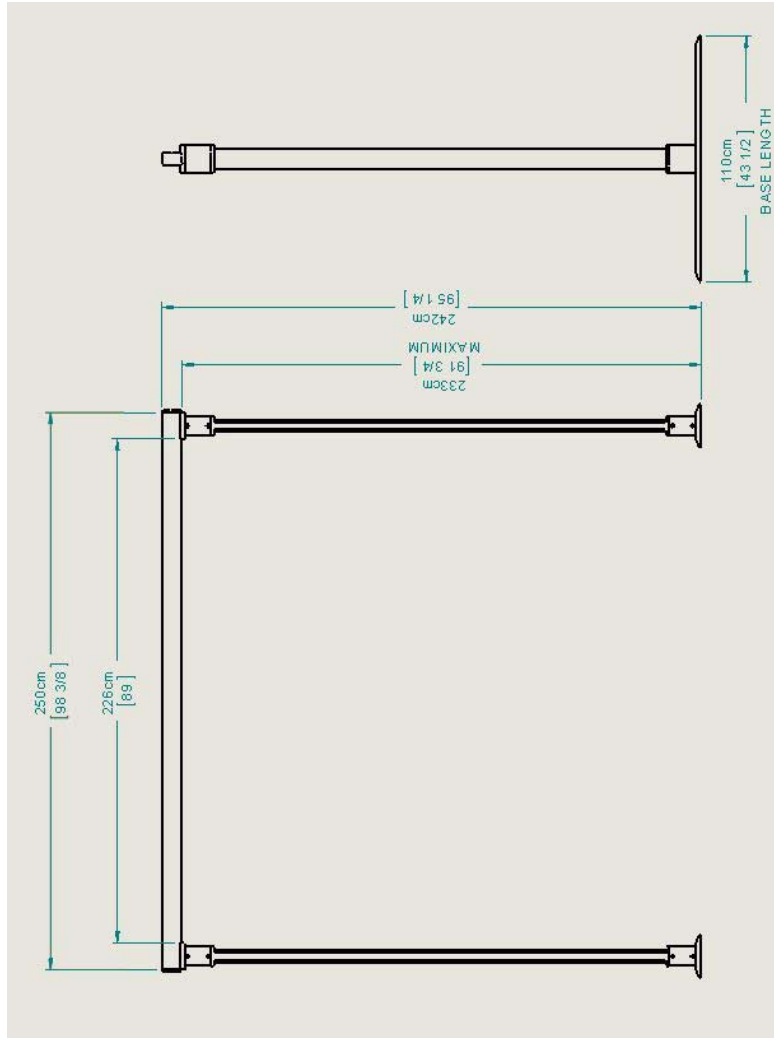

5. MAINTENANCE

The Gantry is subject to wear and tear from use. You must perform the checks and actions in the following tables ensure safety and proper operation.



Contact your Authorized OpeMed Dealer to perform the Dealer Checks/Actions. Safety-related maintenance and service must be performed by an Authorized OpeMed Dealer.

This maintenance schedules provides the minimum recommendations. In some cases, more frequent checks may be required per local regulations and codes.

To ensure safety of the person being transferred and the operator, do NOT use the equipment if a fault is found or if these regular checks have not been performed.

Operator Maintenance Schedule

Perform the following checks/actions as indicated. If any of the checks fail, contact your Authorized OpeMed Dealer for service or replacement of parts.

Operator Check/Action	Frequency
Check the track and hardware for any damage	Before every use
Ensure the track end stops are securely in place	Before every use
Clean the track	Every 4 months
Check for any loose hardware and tighten as needed	Every 4 months
Check the track, hardware, and trolley wheels for damage	Every year

Dealer Maintenance Schedule

Perform the checks/actions listed in the Operator Maintenance Schedule as well as those listed in the table below.

Dealer Check/Action	Frequency
Perform a load test on the Gantry with the Safe Working Load	Every year
Check for any loose hardware and tighten as needed	Every year



To avoid potential injury, use only OpeMed parts when replacing parts.

To prevent the person from falling (or objects from falling) that may cause injuries to the person, the operator or other persons, always reinstall the track end stops if they were removed for servicing. Note that the recommended tightening torque is 20 N-m (15 lb-ft).

Figure 14



Inspection and Cleaning

To clean the Gantry, wipe down the structure with a damp cloth using warm water and a cleaner. You can also use wipes that have a 70% v/v solution of isopropyl alcohol.

Do not use phenol, chlorine or any other type of solvent that may damage the finish.

Rub the Gantry vigorously with the cloth or wipe to ensure thorough cleaning of the entire surface.

Dry all surfaces with a soft cloth.

Authorized OpeMed Dealer

OpeTrack Gantry OWNER'S MANUAL

Part No. 001077-EN
© Copyright 2017

OpeMed (Europe) Ltd.
Clockhouse, Farnham,
Surrey, GU9 7UD, United Kingdom
www.OpeMed.net

+44 (0)1252 758 858

For service or questions about this product, please contact your installing dealer.

DEALER NAME: _____

DEALER PHONE: _____

